

**Construction Package for Cold Formed Steel Building
Created for CSC 4136 3-Bedroom, 2-Bath
Job Number CSUN 62893407**



Table Of Contents

| | |
|-----------------------------|----|
| Building Layout Plan | 2 |
| Anchor Bolt Details | 3 |
| Portal Frame Sections | 6 |
| Roof Framing Plan | 10 |
| Girt Layout | 11 |
| Sheeting Layout | 15 |

Construction Package Notes

This construction package is to be used in conjunction with the created order for the job. All lengths and piece marks of materials in this package will correspond to an item in the order. For example, on the Sidewall A girt layout, there will likely be an item with a piece mark of SGA1. This will correspond to a line item in the order with the piece mark of SGA1. Products that do not include a piece mark will be marked with the product code.

All girt layout and sheeting layouts drawings in this construction package are exterior views, and in these illustrations, components are drawn as if viewed from the outside of the building.

All drawings in this construction package are for reference only, and are to be used to supplement the engineering drawings. If any discrepancies occur, the engineering plans will always take precedence.

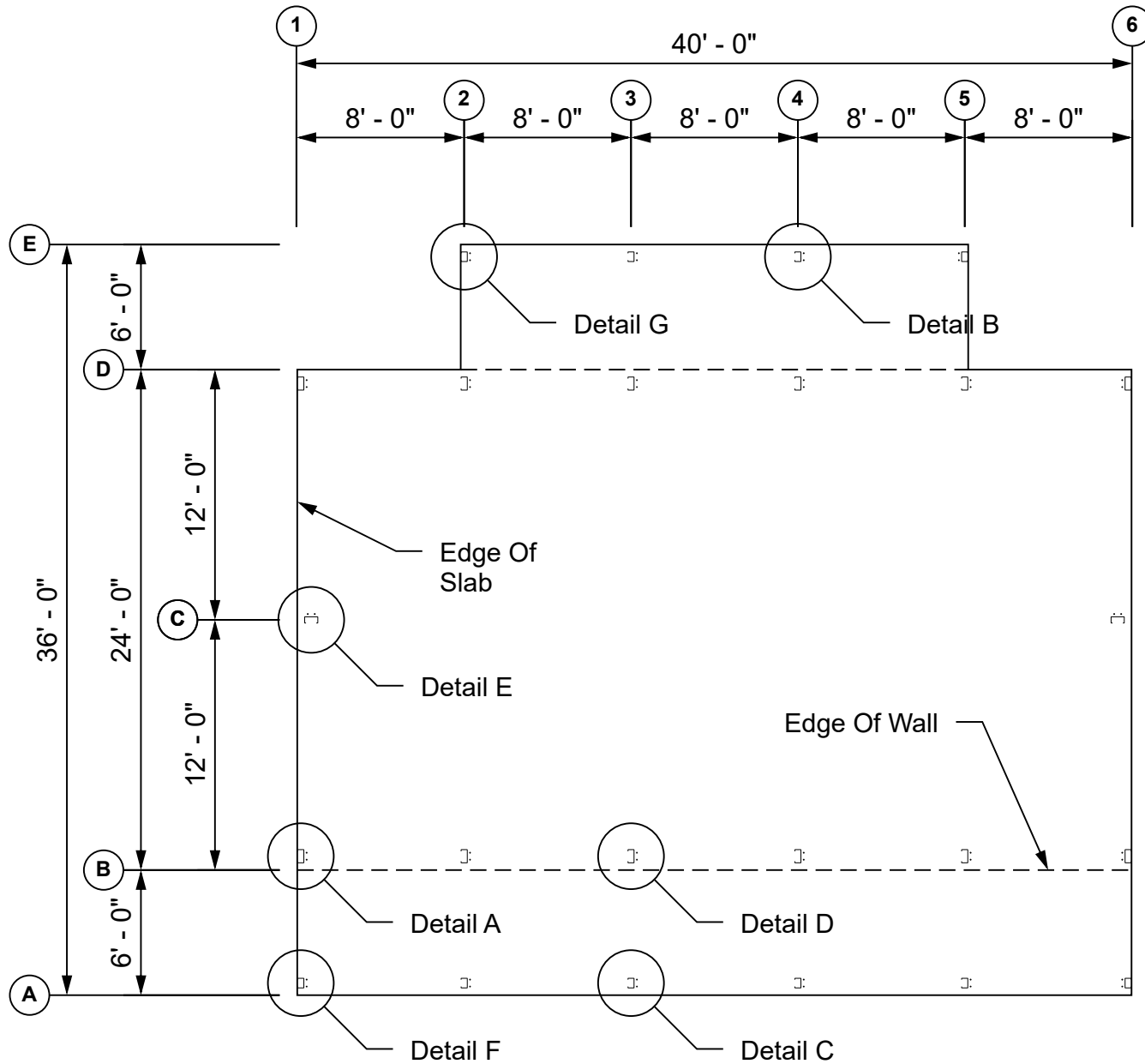

This illustration is for reference only, and is to be used to supplement the engineering drawings. If any discrepancies occur, the engineering plans will always take precedence.



Building Layout Plan



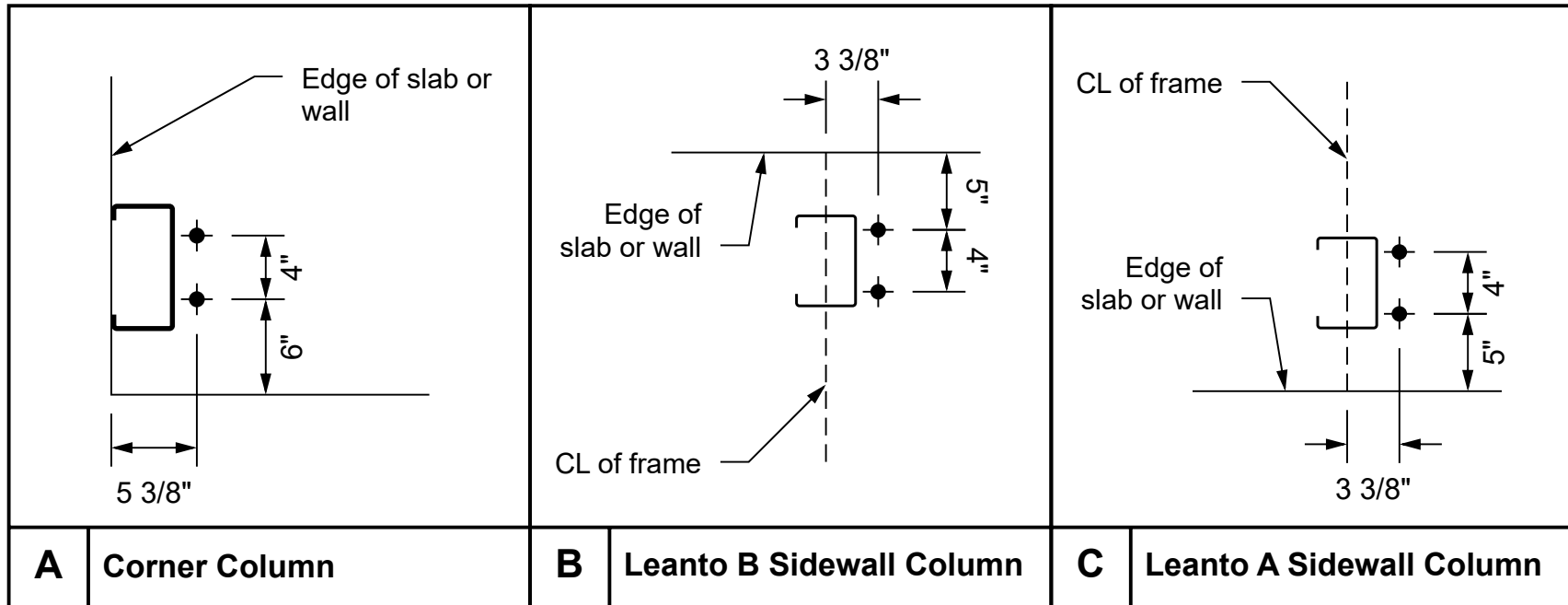

Installation of concrete anchors will require special inspection. Holes must be drilled with a specific drill bit, as noted on the engineering plans.

This illustration is for reference only, and is to be used to supplement the engineering drawings. If any discrepancies occur, the engineering plans will always take precedence.



Anchor Bolt Details



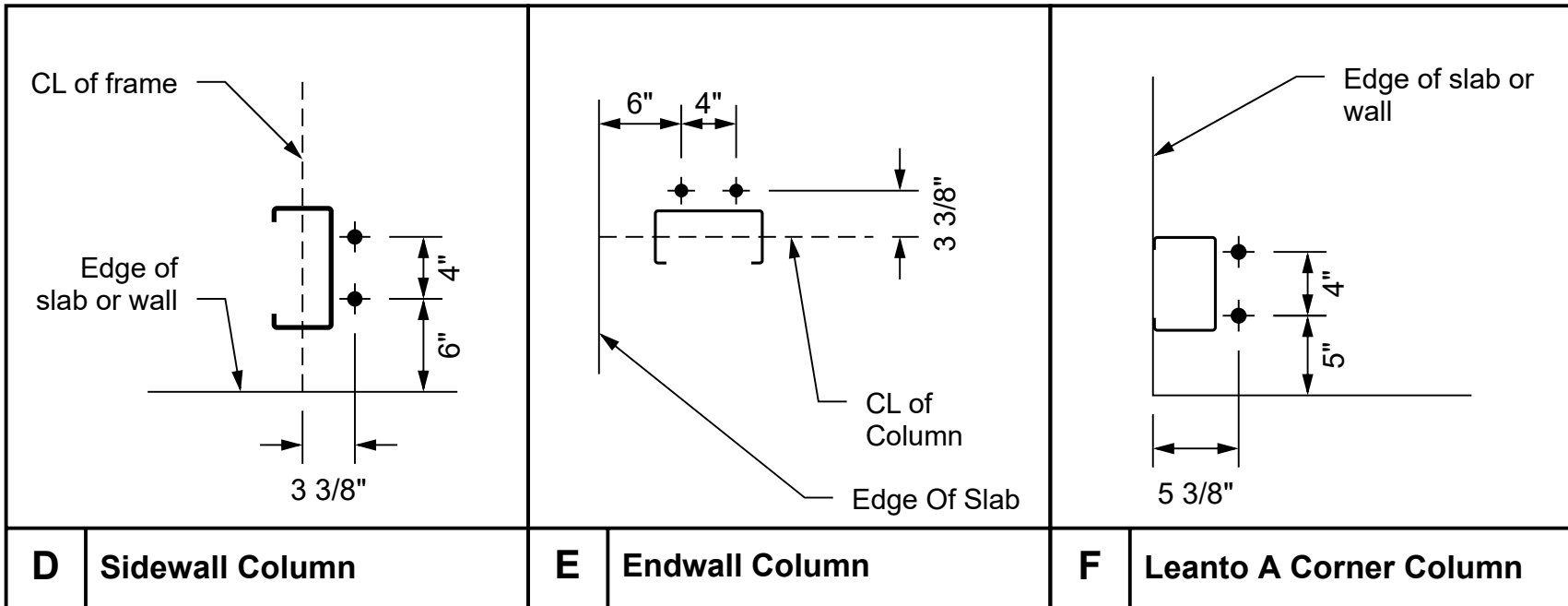

Installation of concrete anchors will require special inspection. Holes must be drilled with a specific drill bit, as noted on the engineering plans.

This illustration is for reference only, and is to be used to supplement the engineering drawings. If any discrepancies occur, the engineering plans will always take precedence.



Anchor Bolt Details



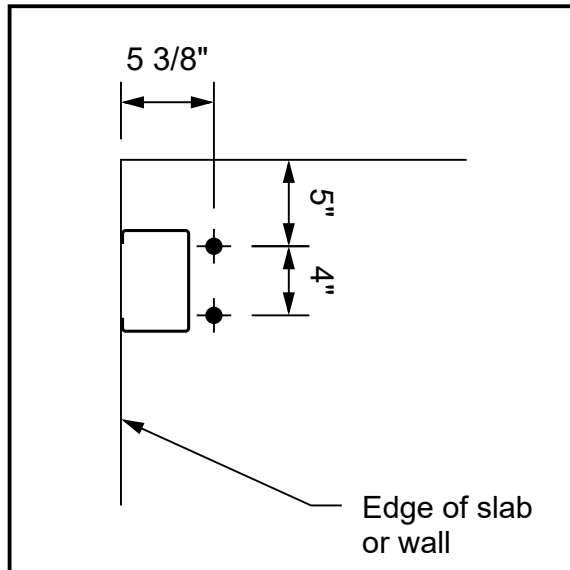

G Leanto B Corner Column

Installation of concrete anchors will require special inspection. Holes must be drilled with a specific drill bit, as noted on the engineering plans.

This illustration is for reference only, and is to be used to supplement the engineering drawings. If any discrepancies occur, the engineering plans will always take precedence.



Anchor Bolt Details



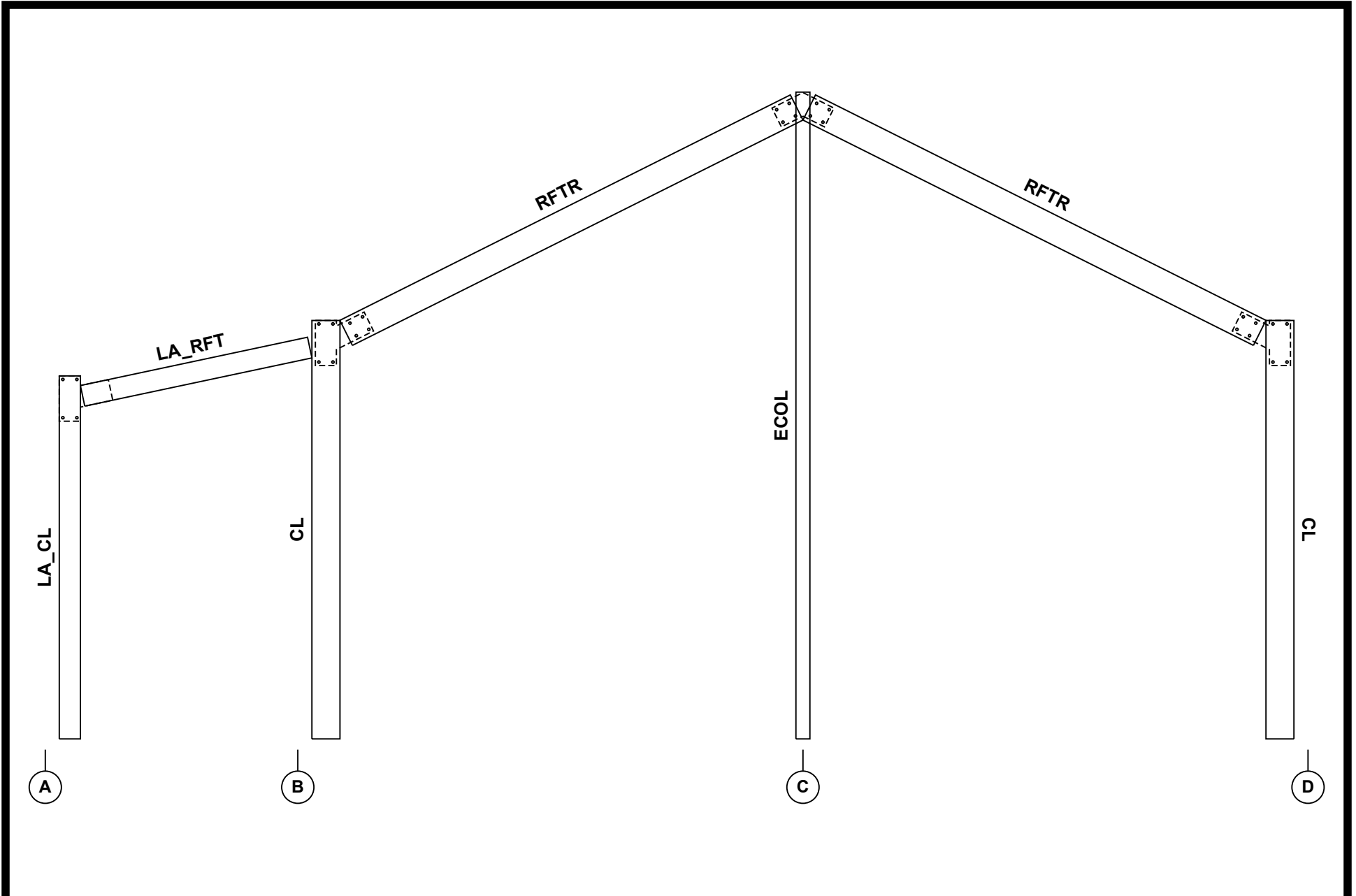

This illustration is for reference only, and is to be used to supplement the engineering drawings. If any discrepancies occur, the engineering plans will always take precedence.



Portal Section, Frame Line 1



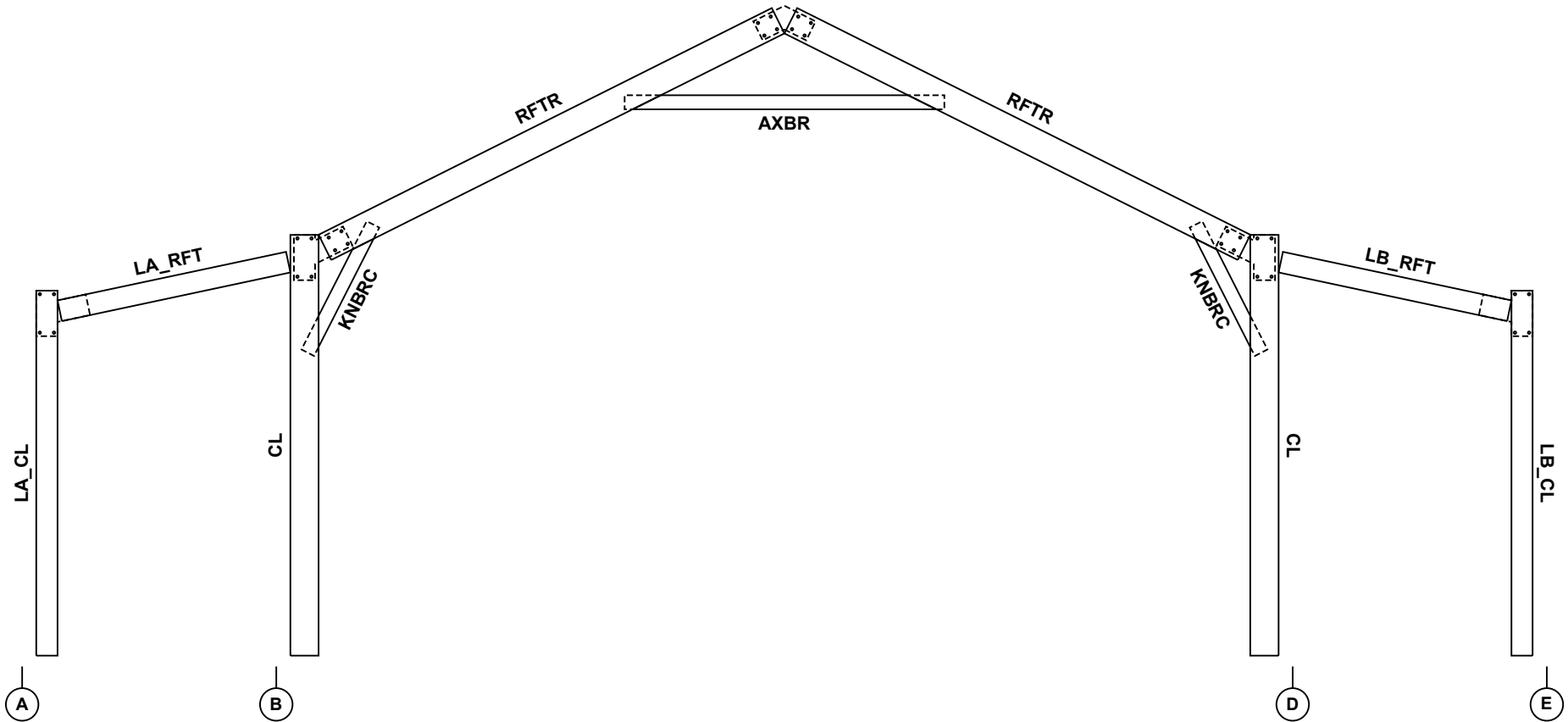

This illustration is for reference only, and is to be used to supplement the engineering drawings. If any discrepancies occur, the engineering plans will always take precedence.



Portal Section, Frame Lines 2, 3, and 4



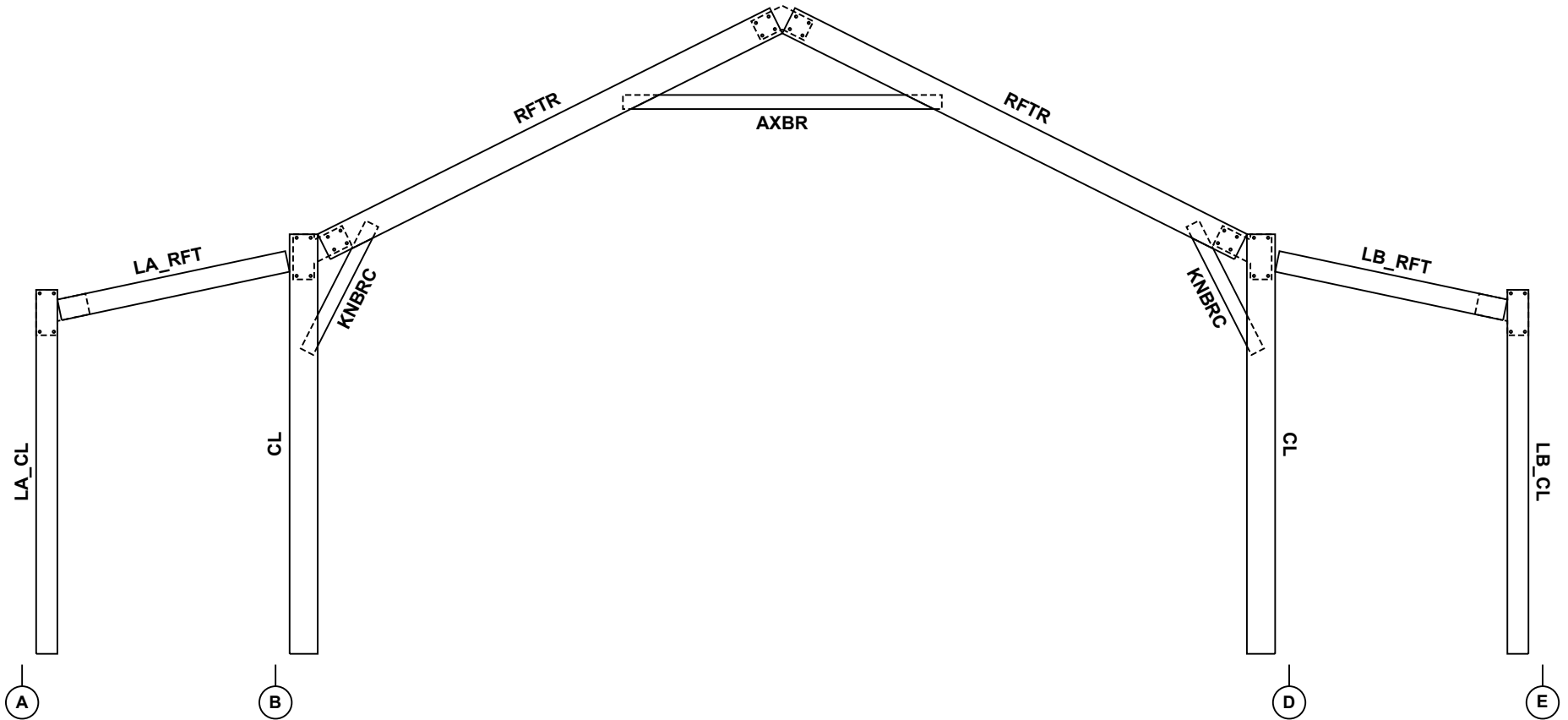

This illustration is for reference only, and is to be used to supplement the engineering drawings. If any discrepancies occur, the engineering plans will always take precedence.



Portal Section, Frame Line 5



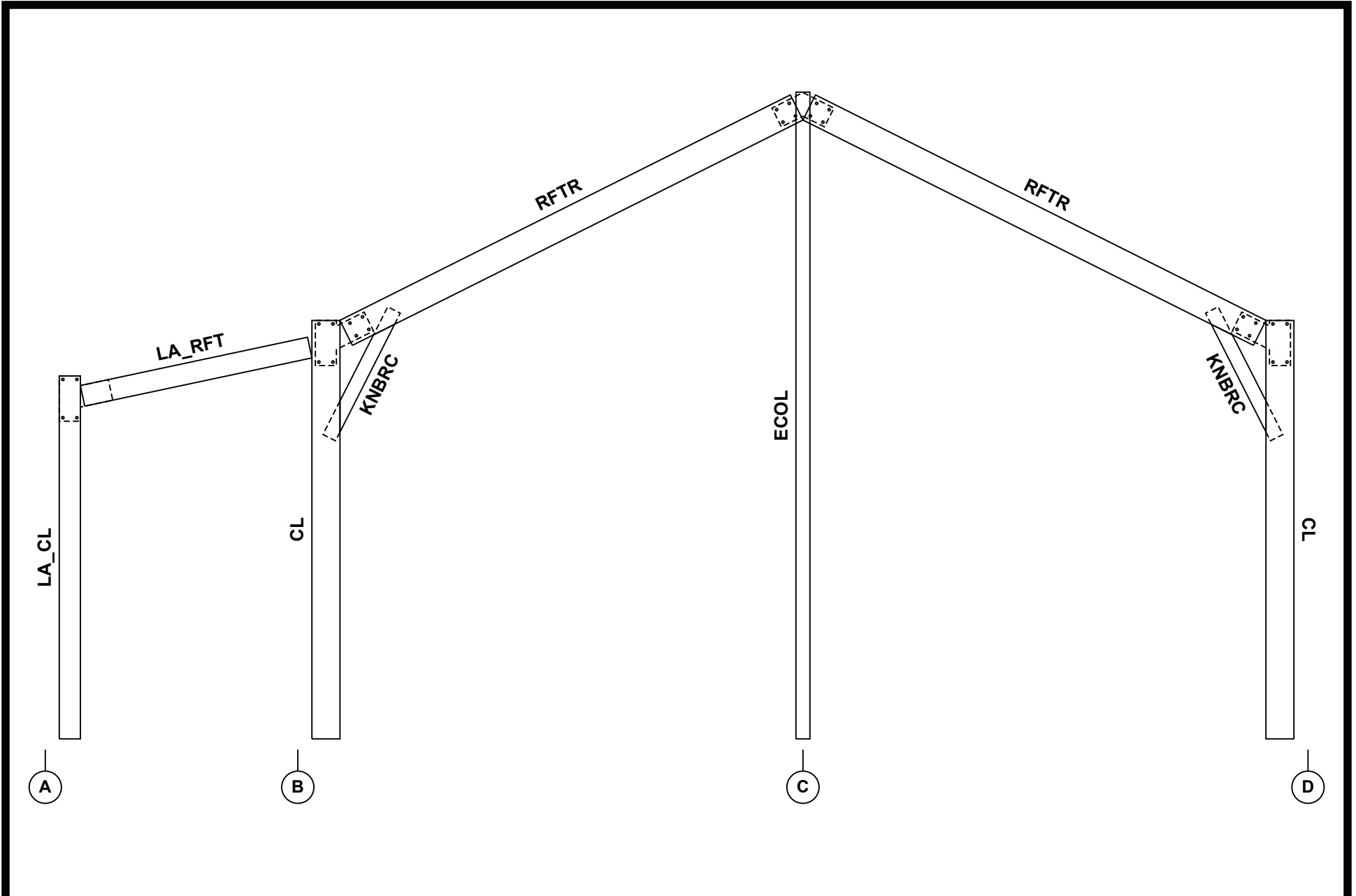

This illustration is for reference only, and is to be used to supplement the engineering drawings. If any discrepancies occur, the engineering plans will always take precedence.



Portal Section, Frame Line 6



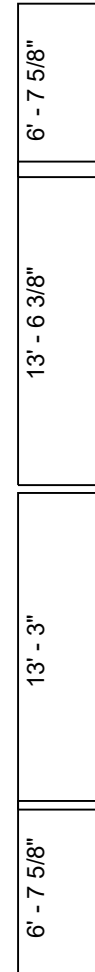
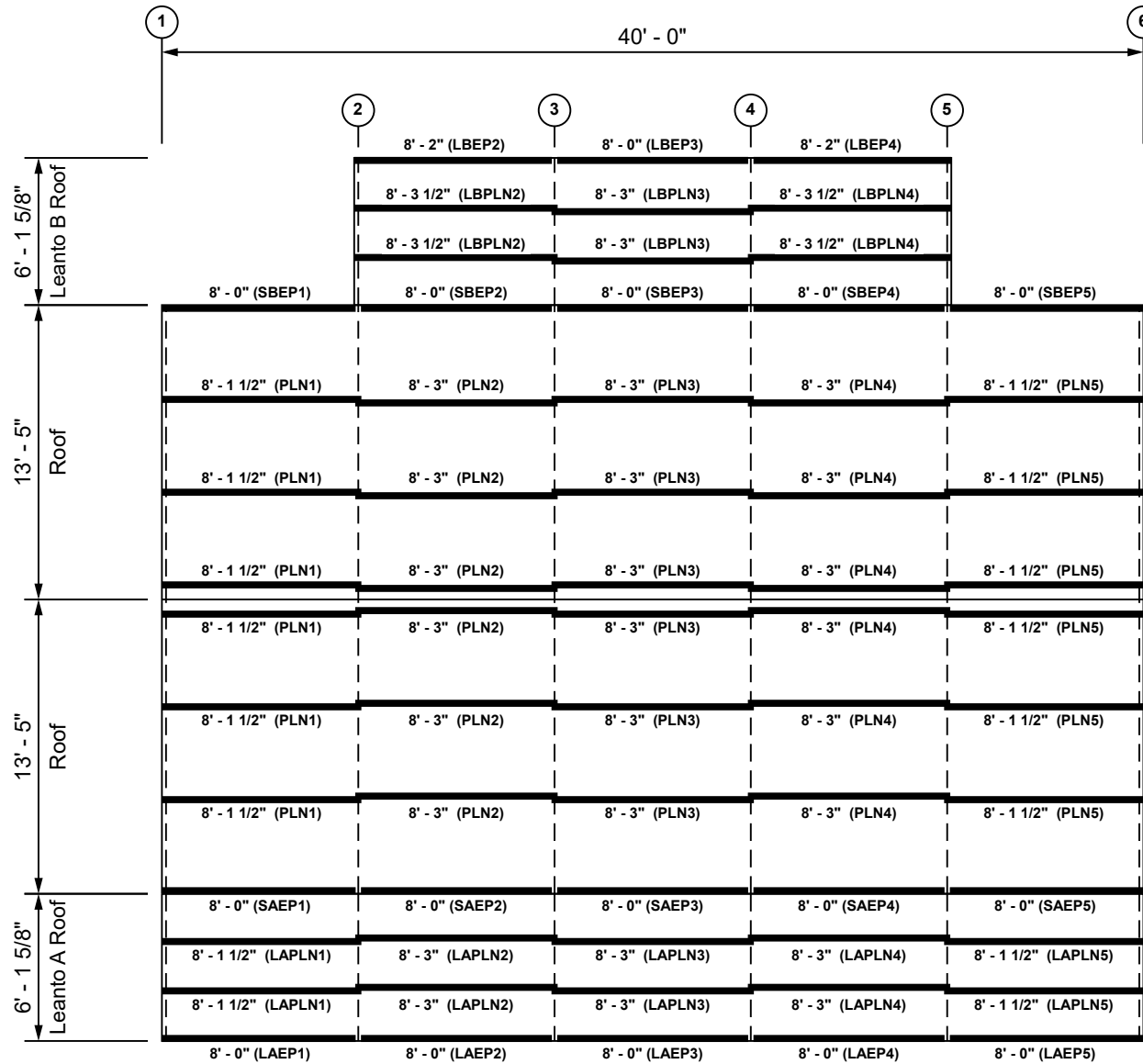

Roof Sheeting:
 Super R-Panel 26G
 Chocolate Brown

This illustration is for reference only, and is to be used to supplement the engineering drawings. If any discrepancies occur, the engineering plans will always take precedence.



Roof Framing Plan



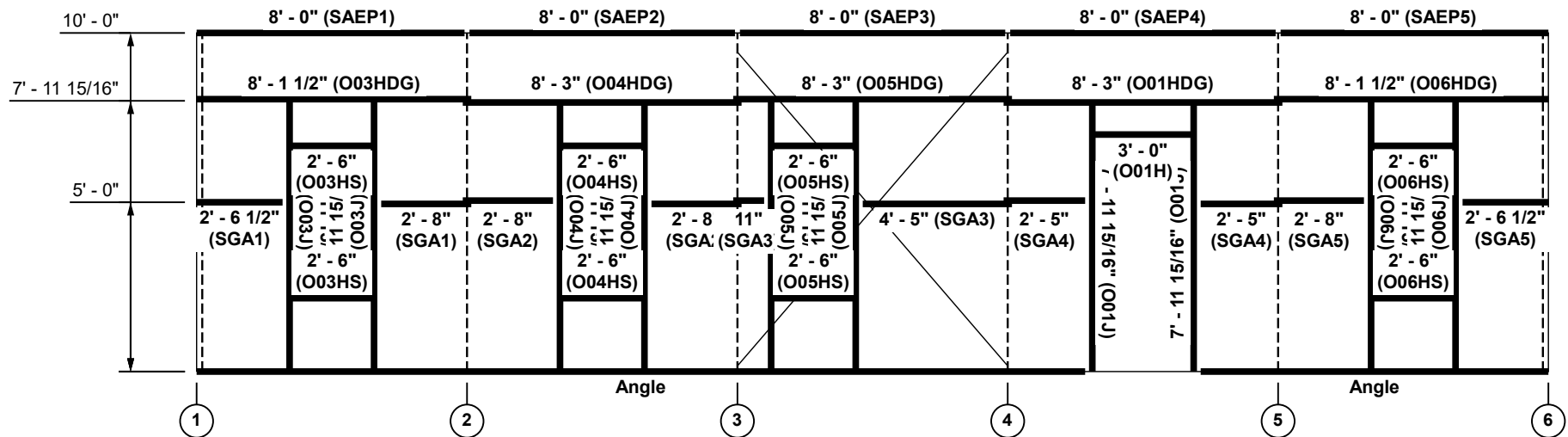

This illustration is for reference only, and is to be used to supplement the engineering drawings. If any discrepancies occur, the engineering plans will always take precedence.



Sidewall A Girt Layout, Frame Line B



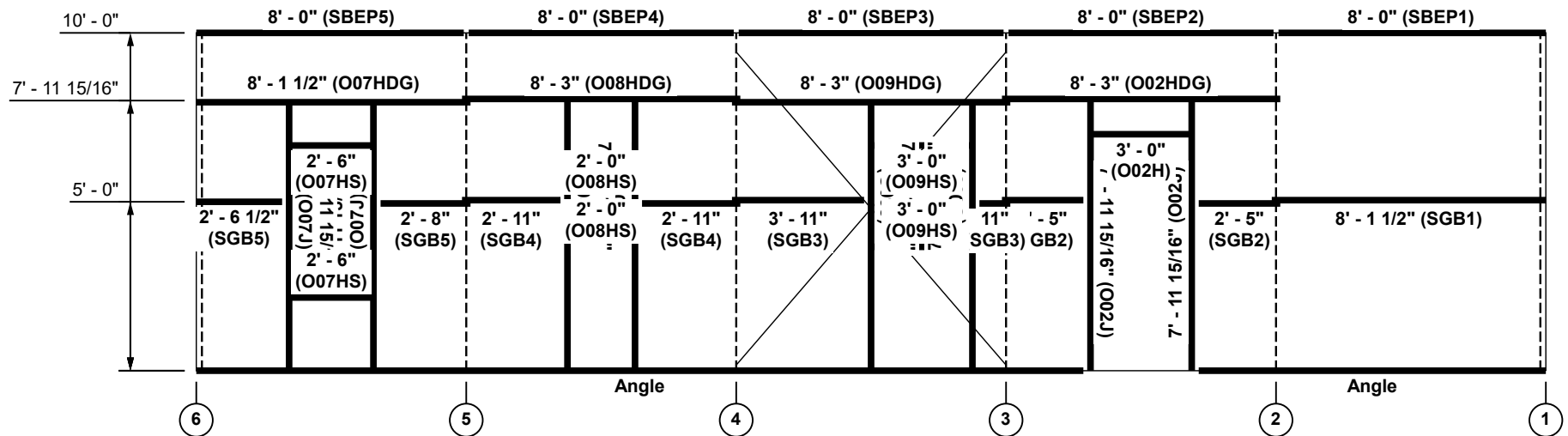

This illustration is for reference only, and is to be used to supplement the engineering drawings. If any discrepancies occur, the engineering plans will always take precedence.



Sidewall B Girt Layout, Frame Line D



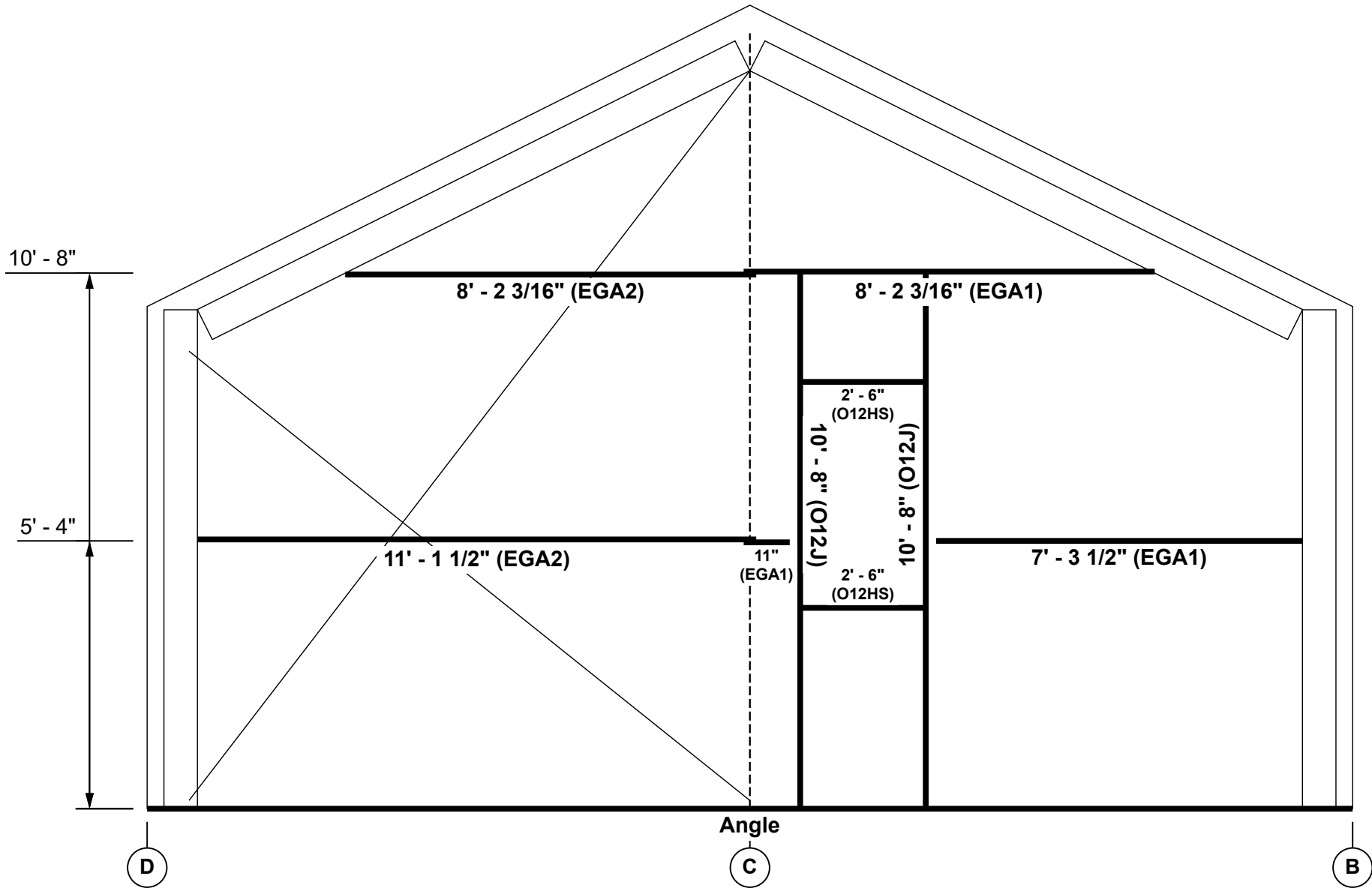

This illustration is for reference only, and is to be used to supplement the engineering drawings. If any discrepancies occur, the engineering plans will always take precedence.



Endwall A Girt Layout, Frame Line 1



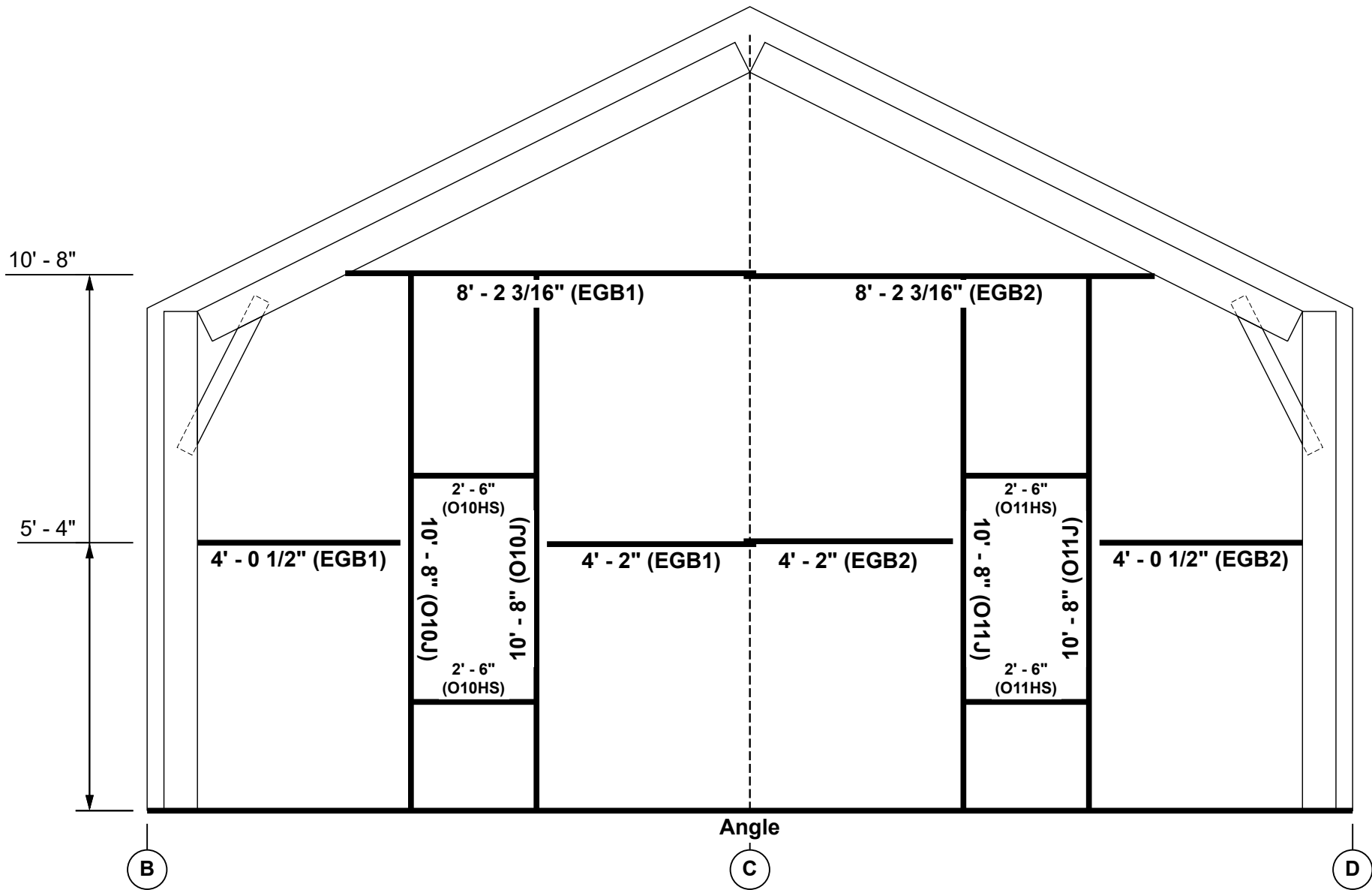

This illustration is for reference only, and is to be used to supplement the engineering drawings. If any discrepancies occur, the engineering plans will always take precedence.



Endwall B Girt Layout, Frame Line 6



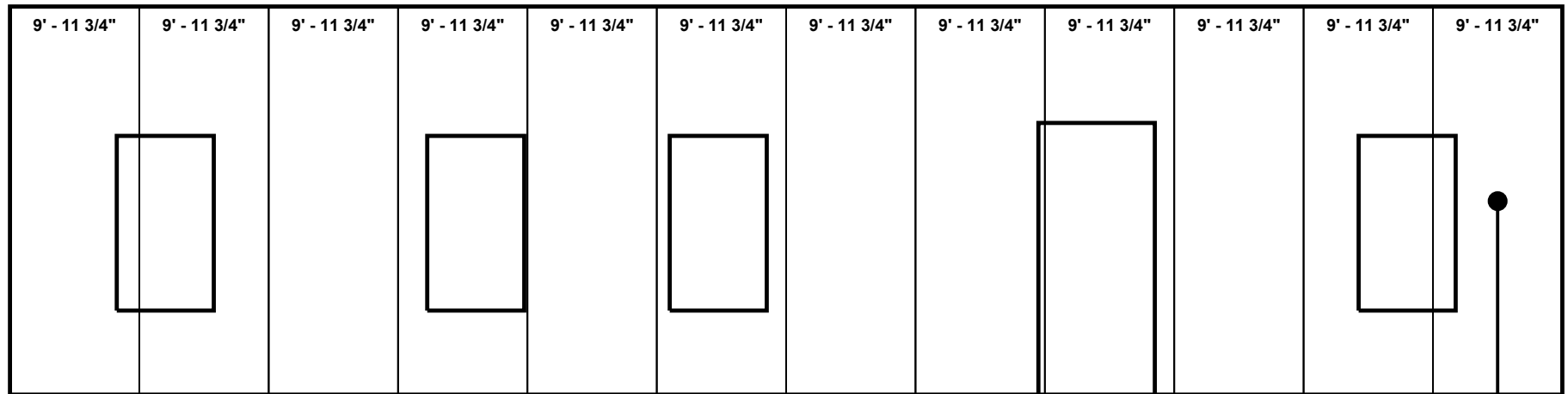

←
**Sheeting starts with this sheet
 and moves across the wall**

This illustration is for reference only, and is to be used to supplement the engineering drawings. If any discrepancies occur, the engineering plans will always take precedence.



Sidewall A Sheeting Layout, Frame Line B



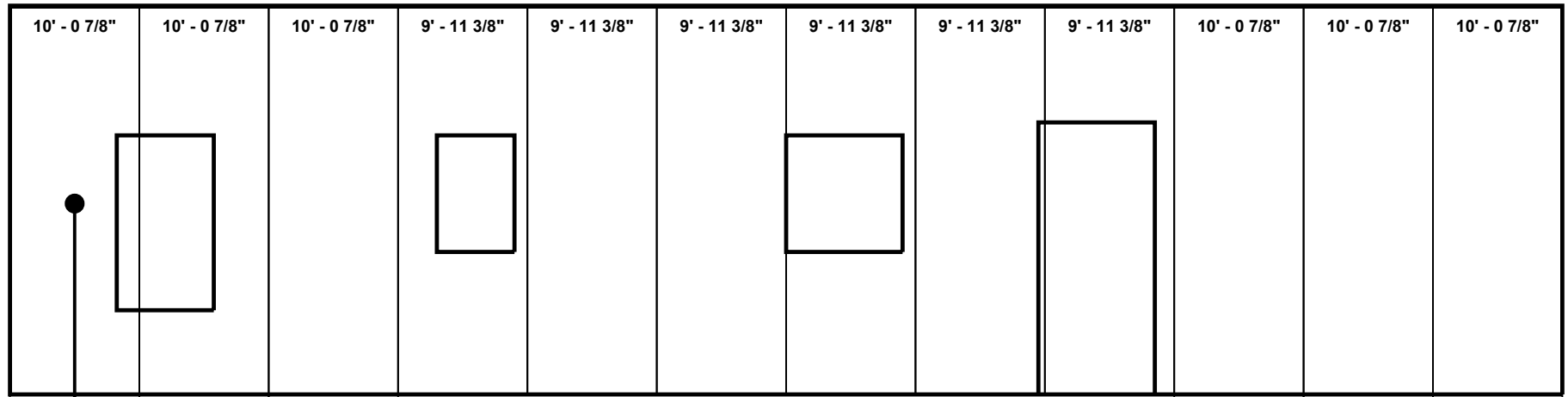

Sheeting starts with this sheet and moves across the wall

This illustration is for reference only, and is to be used to supplement the engineering drawings. If any discrepancies occur, the engineering plans will always take precedence.



Sidewall B Sheeting Layout, Frame Line D



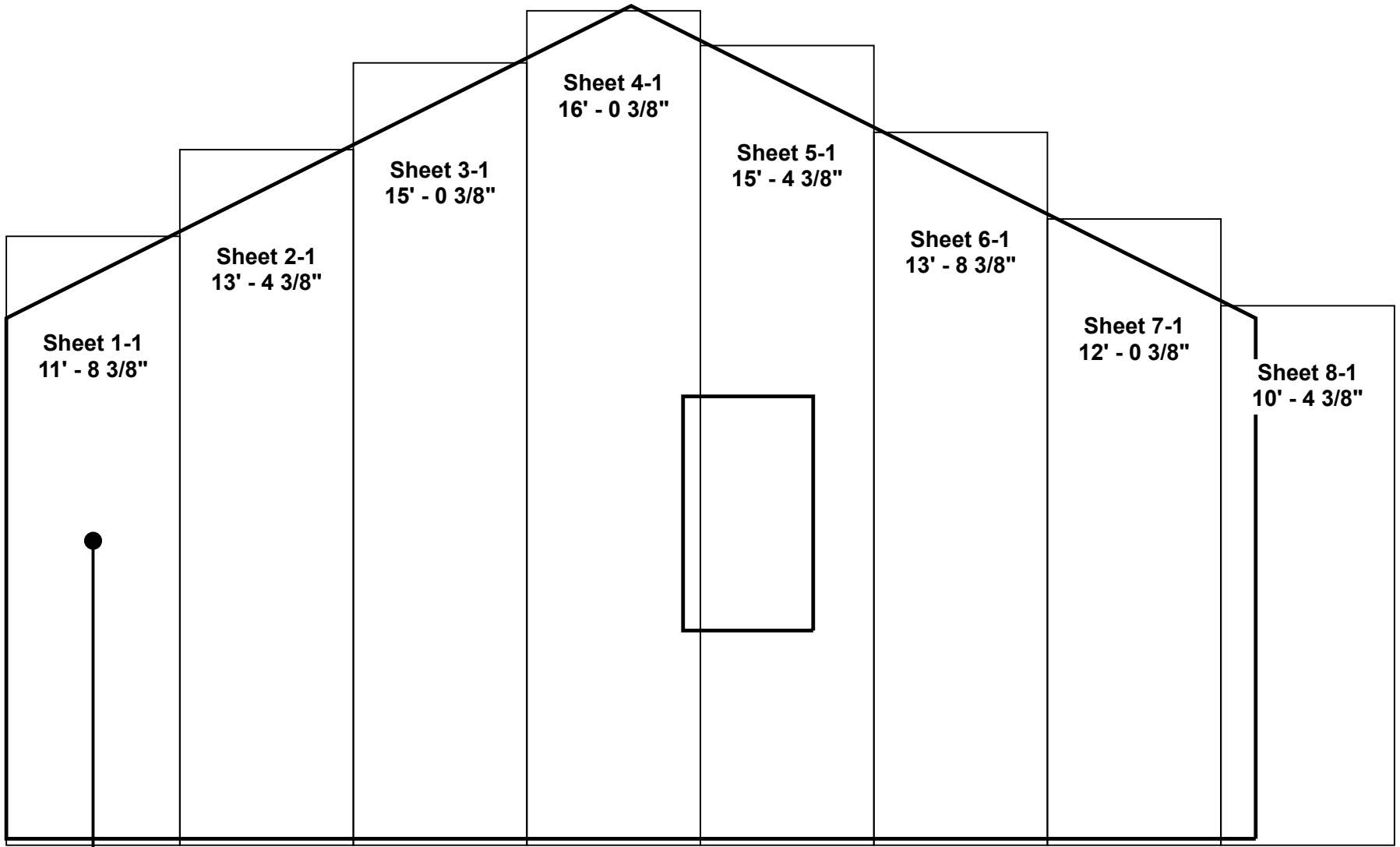

Sheeting starts with this sheet and moves across the wall

This illustration is for reference only, and is to be used to supplement the engineering drawings. If any discrepancies occur, the engineering plans will always take precedence.



Endwall A Sheeting Layout, Frame Line 1



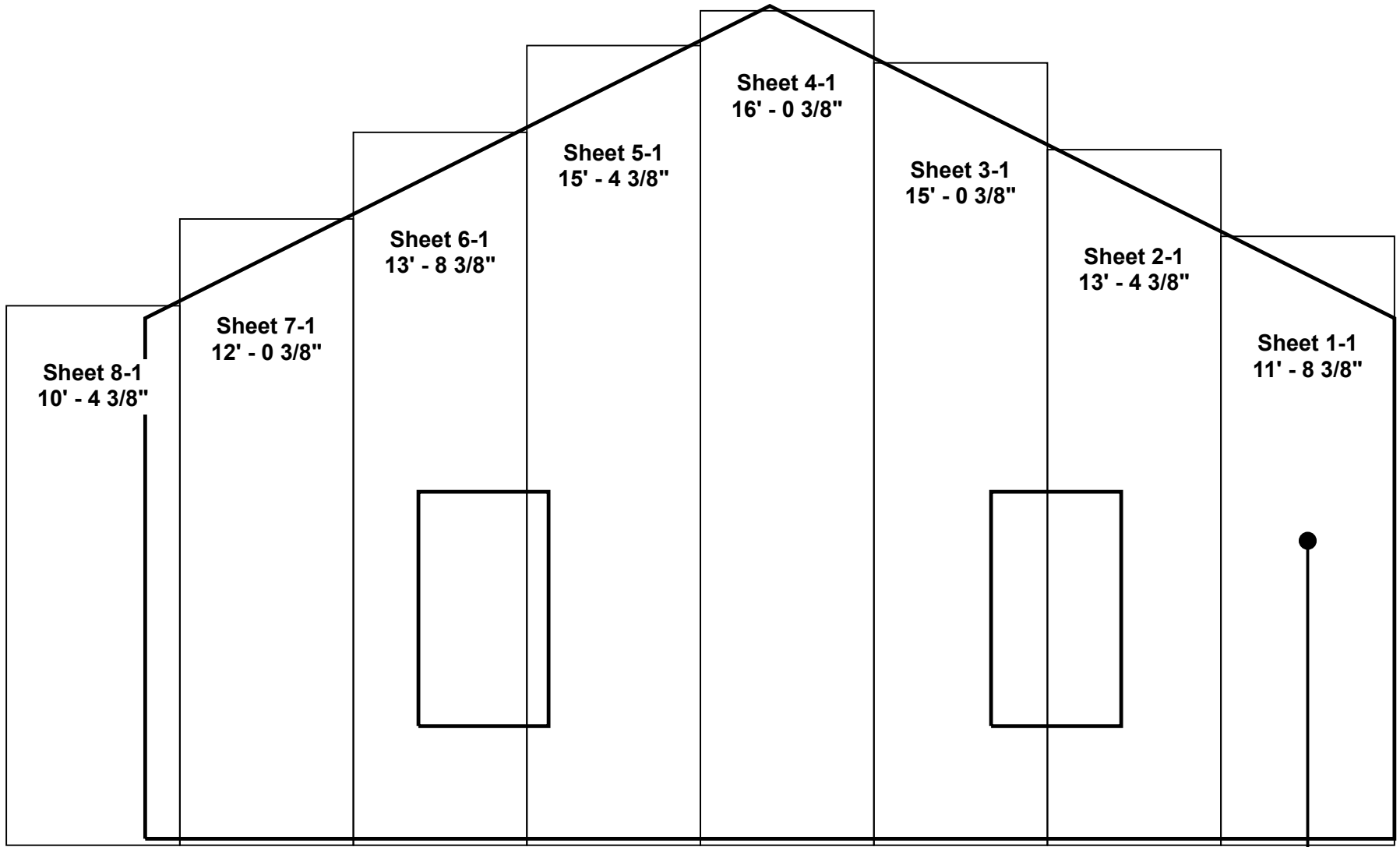

←
**Sheeting starts with this sheet
 and moves across the wall**

This illustration is for reference only, and is to be used to supplement the engineering drawings. If any discrepancies occur, the engineering plans will always take precedence.



Endwall B Sheeting Layout, Frame Line 6

