



CSC1838 WITH ROOFING AND SIDING

CSC Building Systems introduces the Weekender Series. Developed as a place to escape “city” life, where one can get back to nature and the simple ways of life. The **Weekender Series** is an engineered steel framing system specifically designed for the recreational market. The economical lightweight steel frames are easily transported and can be put up quickly by two or three workers without any special lifting equipment. This makes it the perfect framing package for the advanced Do-It-Yourselfer.

When the stress of today’s hectic lifestyle gets to be too much, wouldn’t it be nice to escape to your weekend retreat and cultivate your true perspective on life. **This single story cabin offers a very economical and efficient use of space, and creates a welcoming atmosphere for this charming cottage.**

CSC Building Systems has re-designed the Weekender Series, making it more flexible, easier to build, and less expensive. **The NEW “Rigid Frame” design does not depend on any interior bearing walls, therefore providing a blank slate for interior floor plans. Walls may be of any type and material you would like to use and may be arranged according to your design. They may be moved or changed at any time without affecting the structural integrity of the cabin. Interior walls may be built with steel studs (optional CSC item), wood studs, or panels of your design.**

This Cabin Kit Includes a complete steel frame, Painted Steel Roofing, Painted Steel Siding, and Painted Steel Trim, to complete the CSC1838 cabin shell. The deck, stairs, and railing materials are **not included**.

THIS KIT IS BUILT ON A CONCRETE SLAB, FIRST FLOOR FRAMING (OPTIONAL CSC ITEM) IS NOT INCLUDED.

What is INCLUDED with this Kit?

1. Complete Galvanized Steel frame for the roof, and walls
2. Galvanized Steel door frames and window frames as per this plan. (field cutting required)
3. Structural Bolts, Braces, and screws required for assembly
4. Painted CSC Metal Roofing
5. Painted CSC Metal Siding
6. Painted CSC Metal Trim
7. All Painted screws, closures, and sealants required for installation
8. Plans for assembly (3 copies)
9. Engineers Stamp on the frame design.
10. Everything to build the CSC1838; as an enclosed exterior shell, EXCEPT the actual windows and doors, and slab or foundation.

What is NOT INCLUDED with this Kit?

1. Anything and everything not listed as included; which includes but is NOT limited to:
 - a. Interior wall framing
 - b. Deck materials
 - c. Furring strips for the inside of the exterior walls for installing insulation, drywall, or paneling. The furring strips may be wood or steel (optional CSC item)
 - d. Drywall, paneling and/or all other finishing material
 - e. Plumbing, electrical, doors, windows, insulation, etc.

**Construction Package for Cold Formed Steel Building
Created for Cabin 1838 With Roofing & Siding
Job Number CSUN 61693522**



Table Of Contents

Building Layout Plan	2
Anchor Bolt Details	3
Portal Frame Sections	4
Roof Framing Plan	7
Girt Layout	8
Sheeting Layout	12

Construction Package Notes

This construction package is to be used in conjunction with the created order for the job. All lengths and piece marks of materials in this package will correspond to an item in the order. For example, on the Sidewall A girt layout, there will likely be an item with a piece mark of SGA1. This will correspond to a line item in the order with the piece mark of SGA1. Products that do not include a piece mark will be marked with the product code.

All girt layout and sheeting layouts drawings in this construction package are exterior views, and in these illustrations, components are drawn as if viewed from the outside of the building.

All drawings in this construction package are for reference only, and are to be used to supplement the engineering drawings. If any discrepancies occur, the engineering plans will always take precedence.

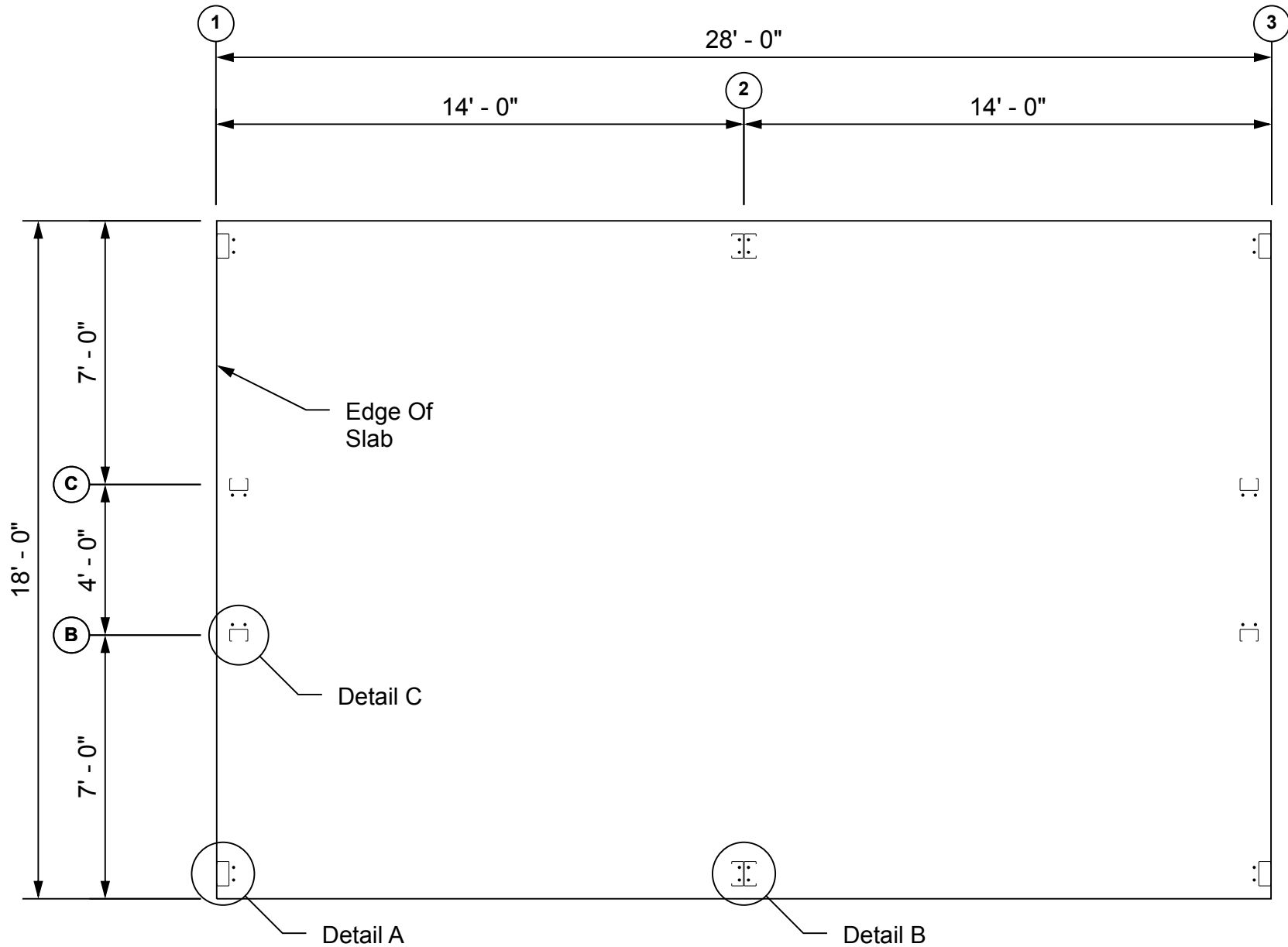

This illustration is for reference only, and is to be used to supplement the engineering drawings. If any discrepancies occur, the engineering plans will always take precedence.



Building Layout Plan



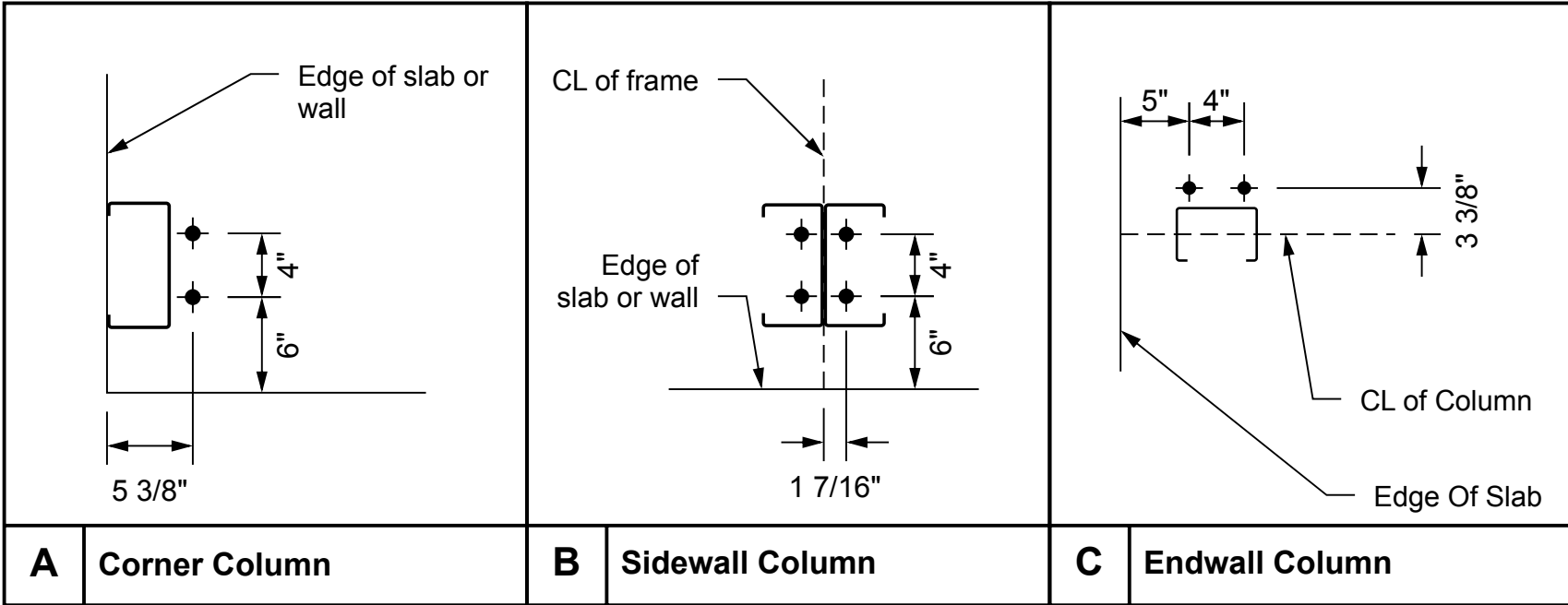

This illustration is for reference only, and is to be used to supplement the engineering drawings. If any discrepancies occur, the engineering plans will always take precedence.



Anchor Bolt Details



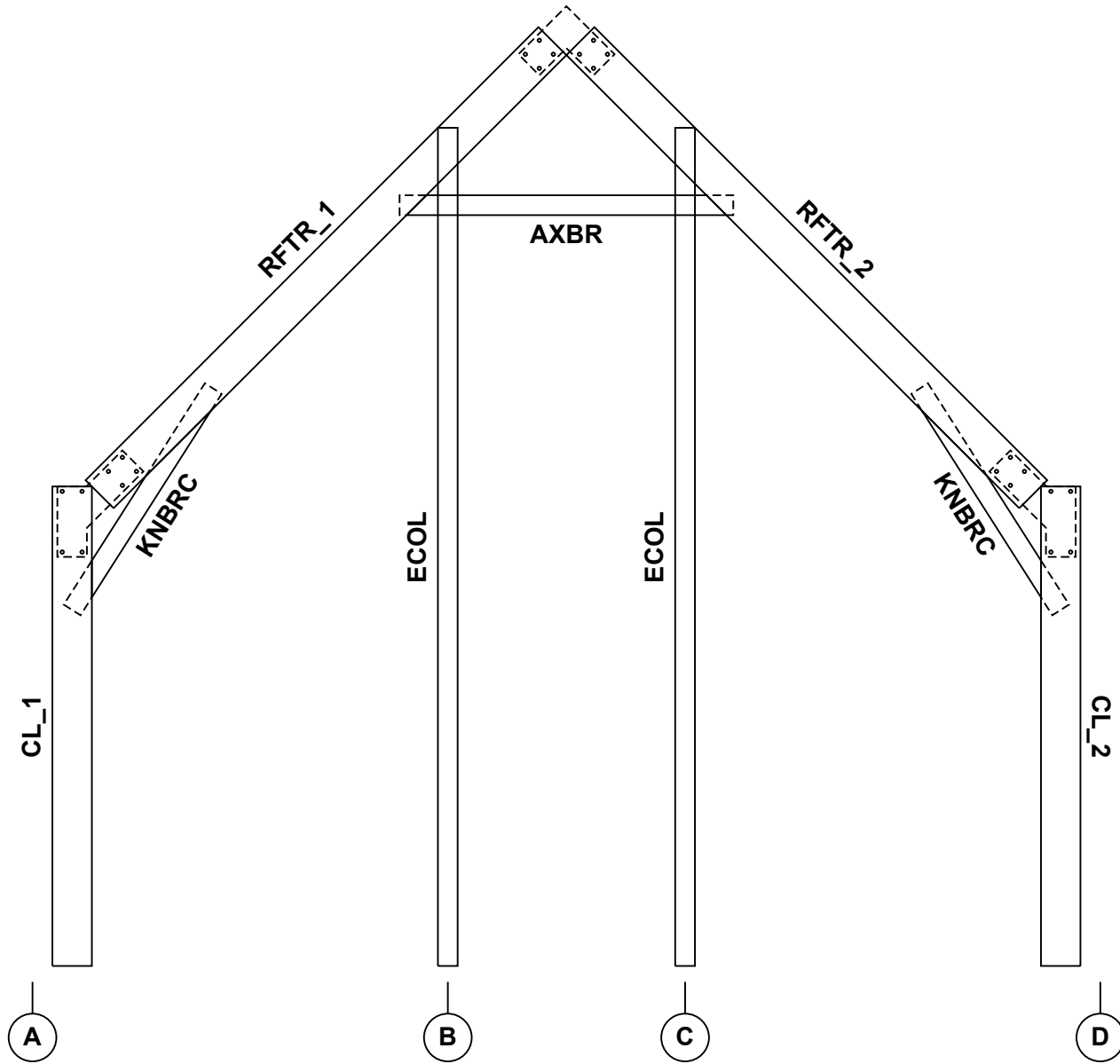

This illustration is for reference only, and is to be used to supplement the engineering drawings. If any discrepancies occur, the engineering plans will always take precedence.



Portal Section, Frame Line 1



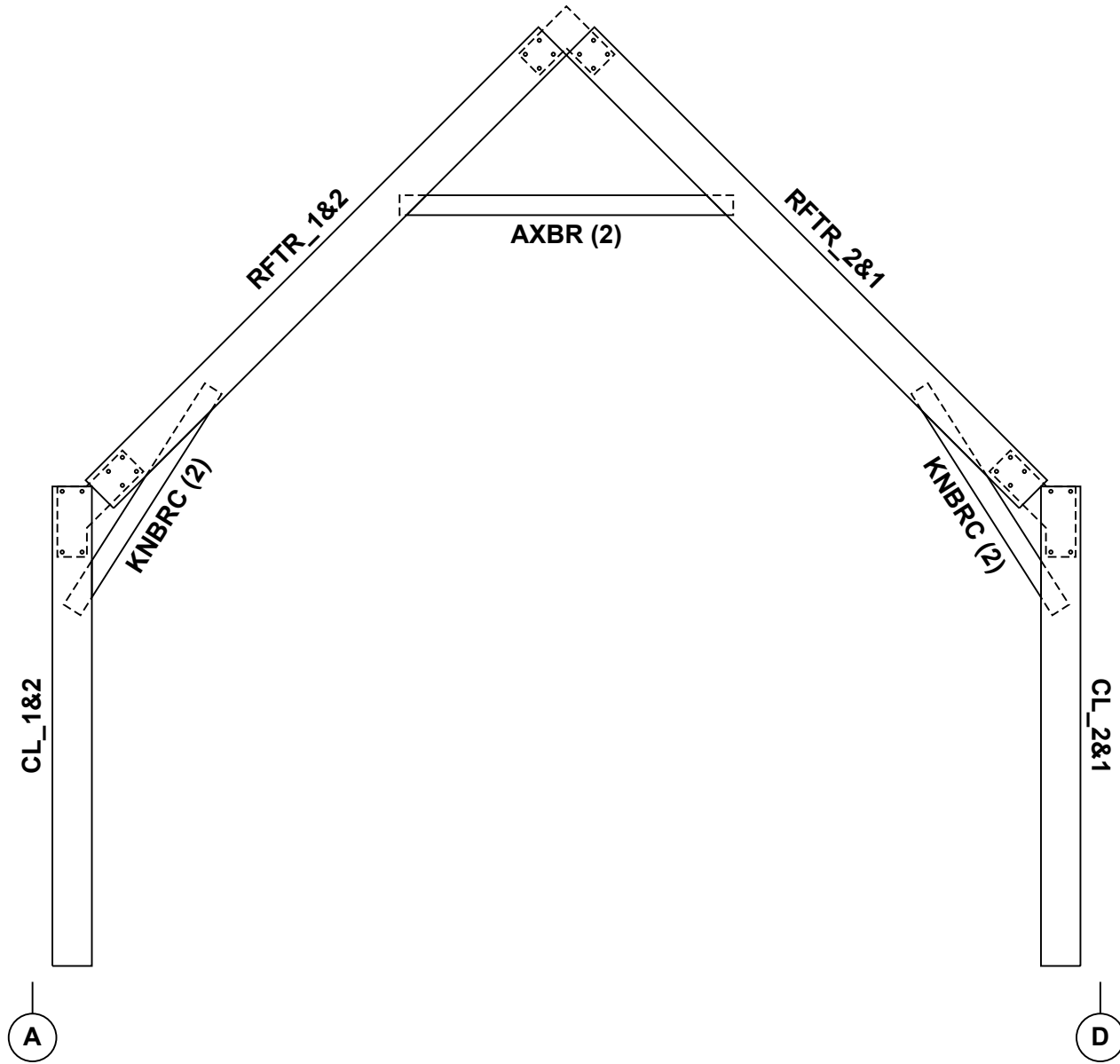

This illustration is for reference only, and is to be used to supplement the engineering drawings. If any discrepancies occur, the engineering plans will always take precedence.



Portal Section, Frame Line 2



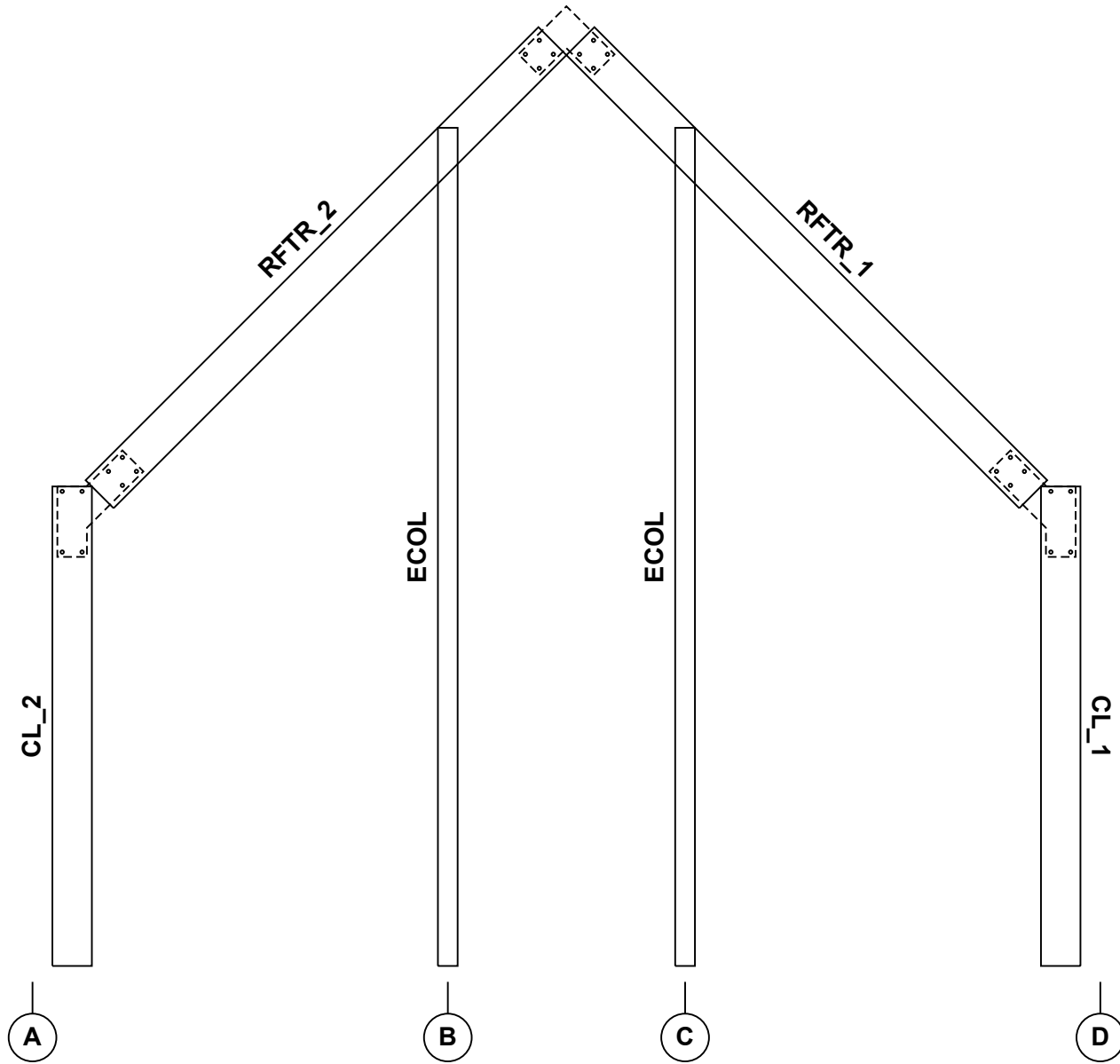

This illustration is for reference only, and is to be used to supplement the engineering drawings. If any discrepancies occur, the engineering plans will always take precedence.



Portal Section, Frame Line 3



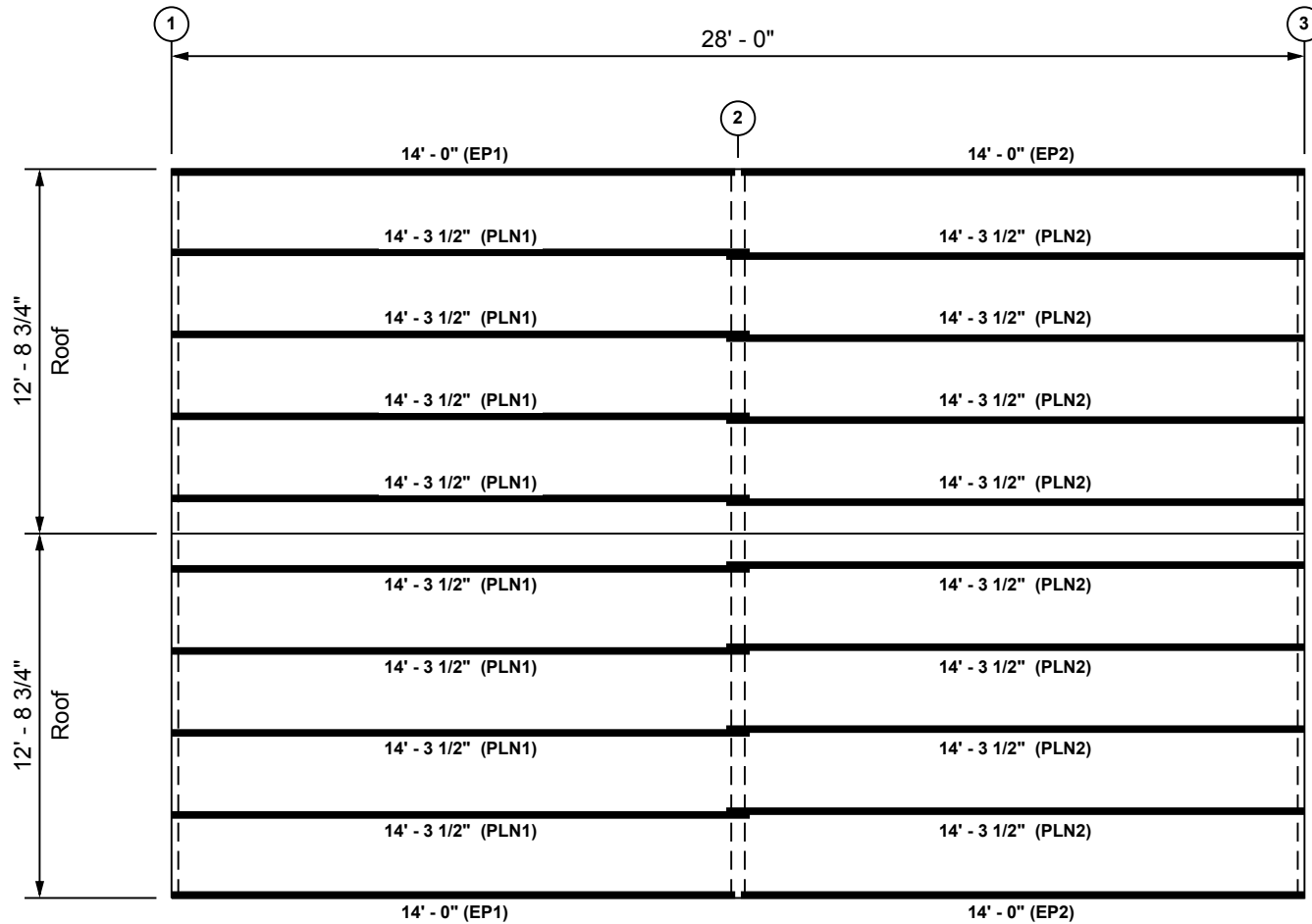

Roof Sheeting:
 Super Delta 26G
 Chocolate Brown

This illustration is for reference only, and is to be used to supplement the engineering drawings. If any discrepancies occur, the engineering plans will always take precedence.



Roof Framing Plan



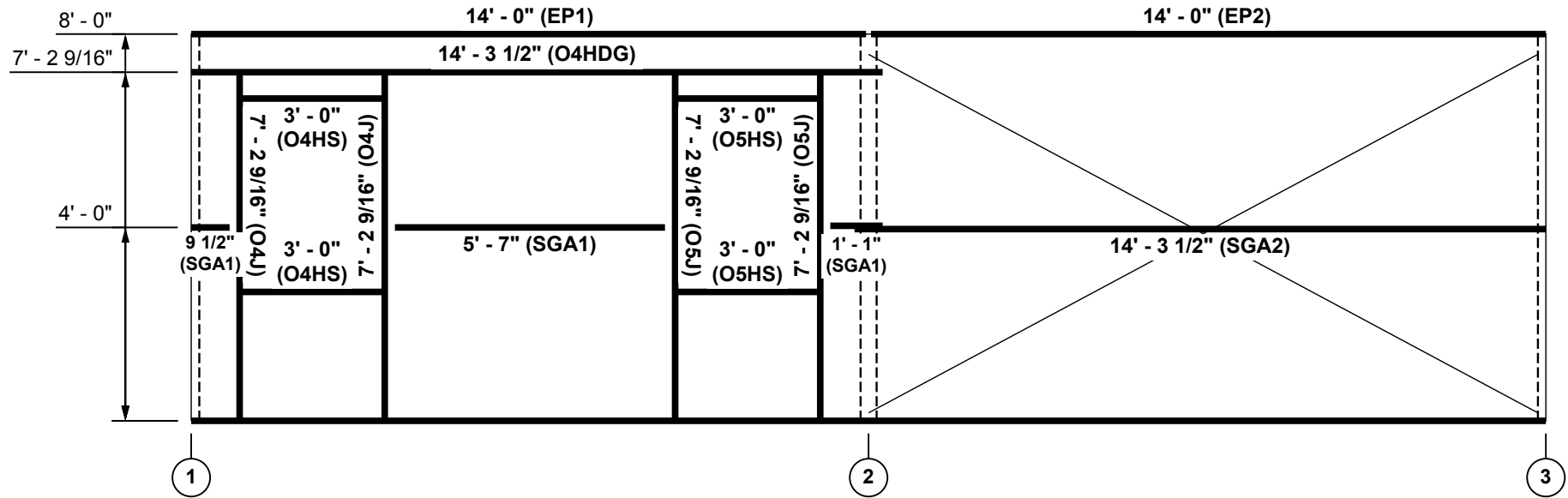

This illustration is for reference only, and is to be used to supplement the engineering drawings. If any discrepancies occur, the engineering plans will always take precedence.



Sidewall A Girt Layout, Frame Line A



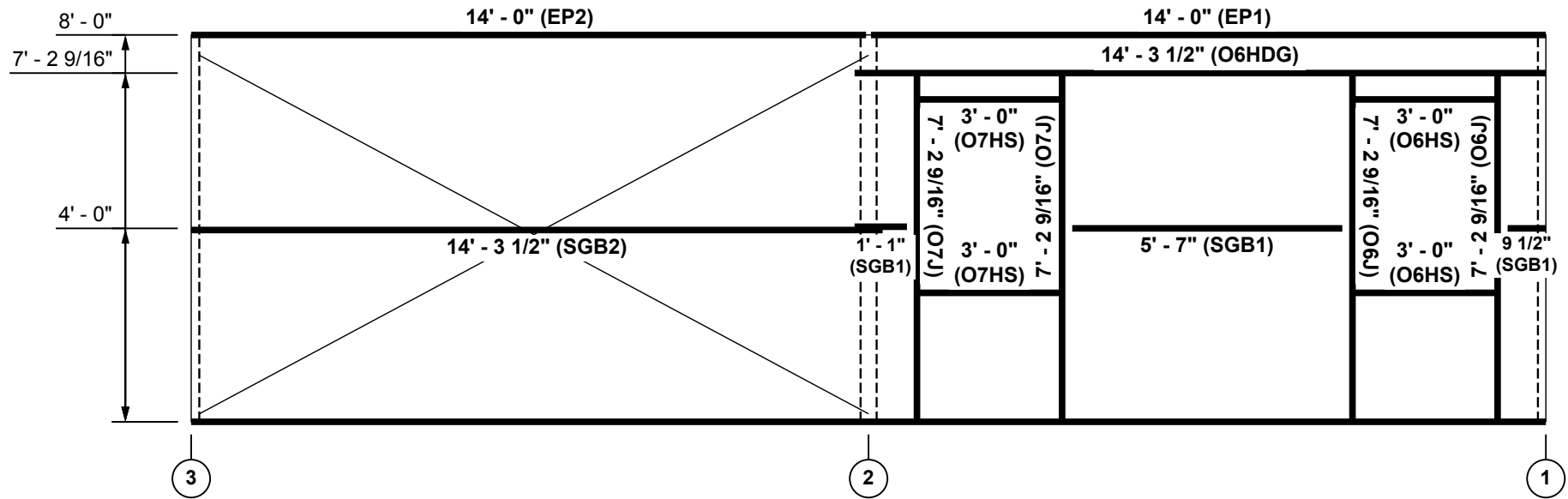

This illustration is for reference only, and is to be used to supplement the engineering drawings. If any discrepancies occur, the engineering plans will always take precedence.



Sidewall B Girt Layout, Frame Line D



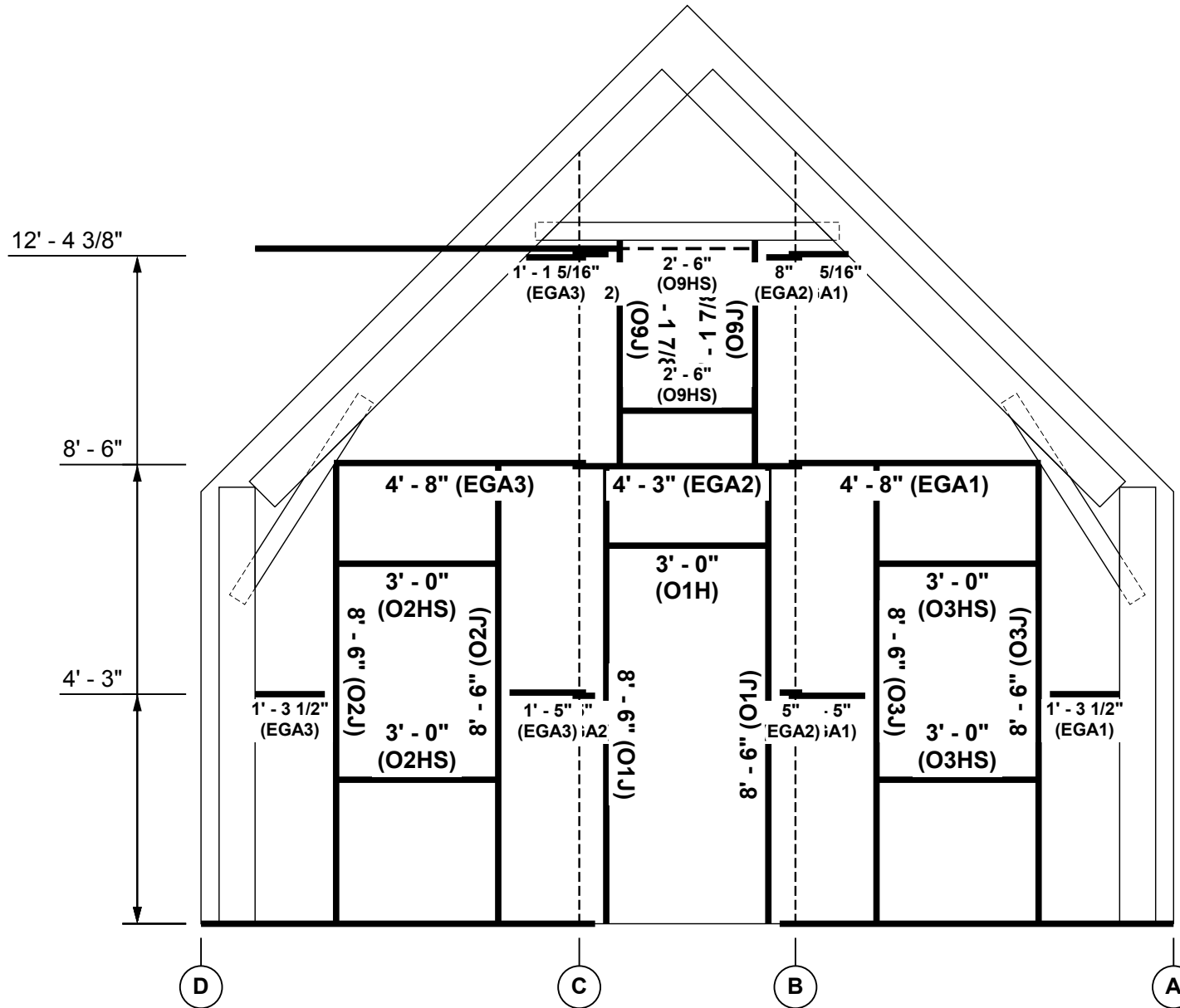

This illustration is for reference only, and is to be used to supplement the engineering drawings. If any discrepancies occur, the engineering plans will always take precedence.



Endwall A Girt Layout, Frame Line 1



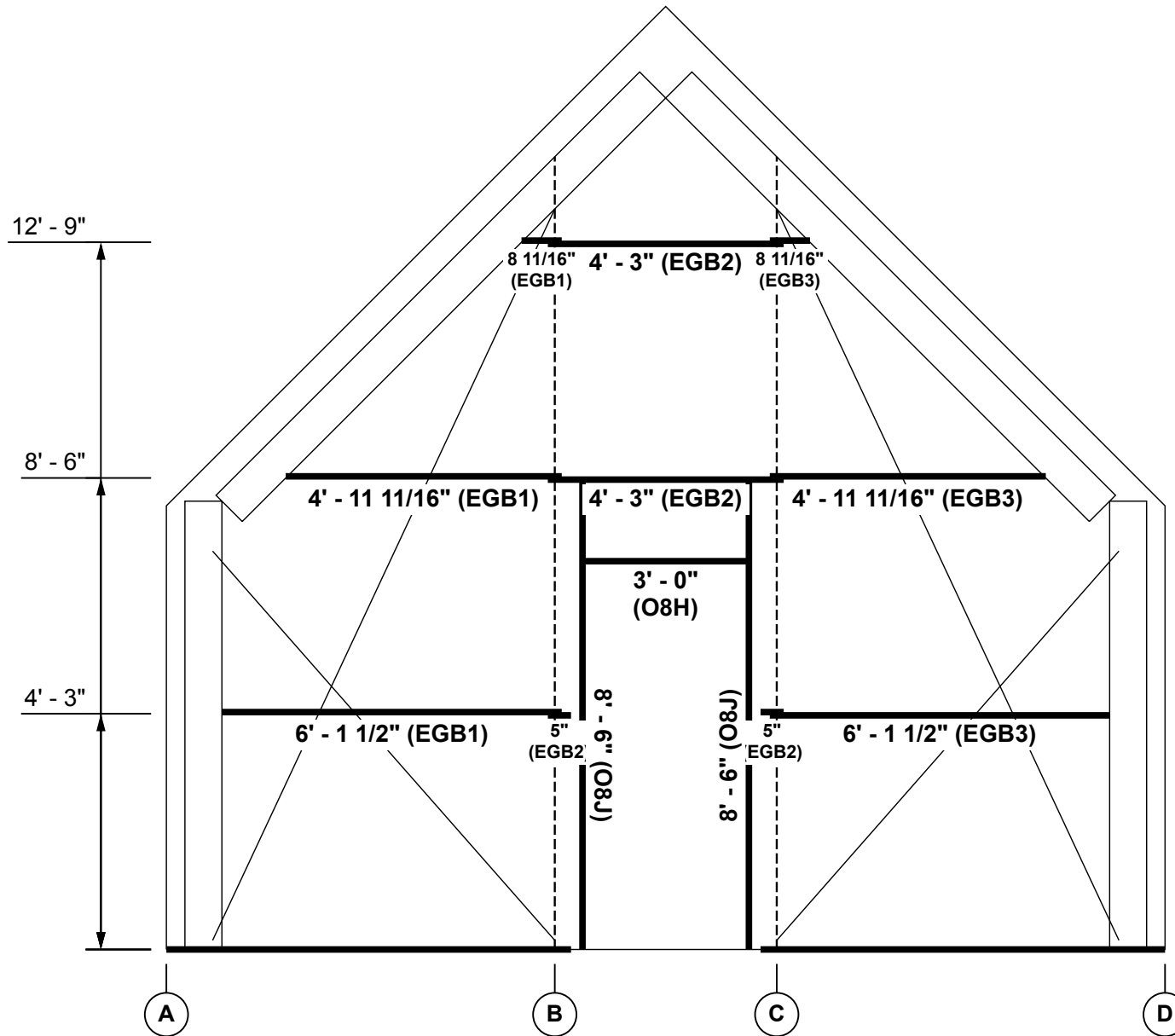

This illustration is for reference only, and is to be used to supplement the engineering drawings. If any discrepancies occur, the engineering plans will always take precedence.



Endwall B Girt Layout, Frame Line 3



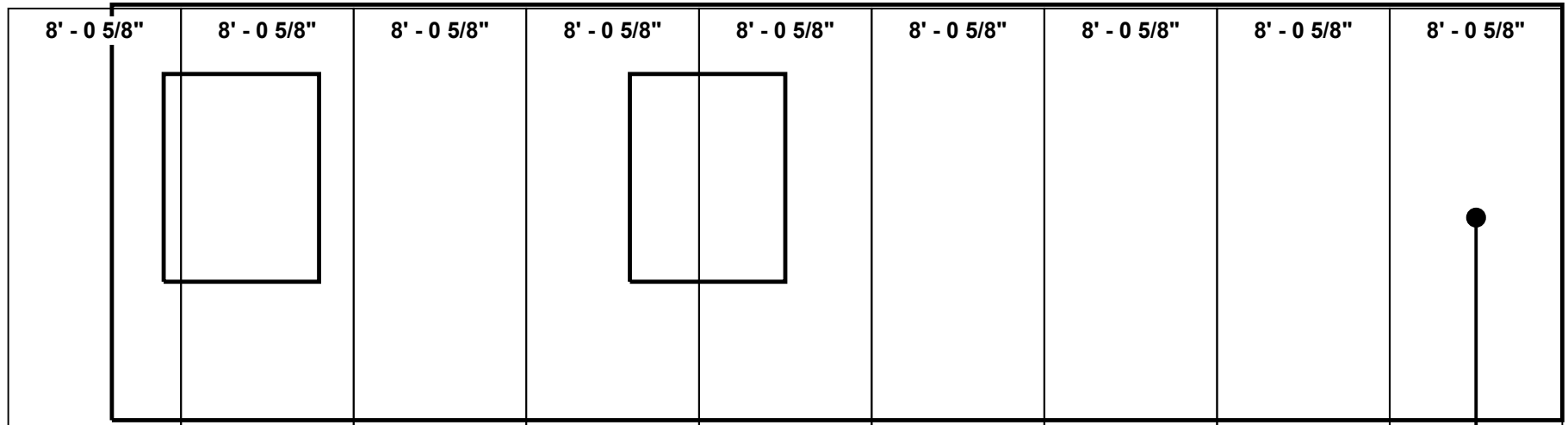

←
**Sheeting starts with this sheet
and moves across the wall**

This illustration is for reference only, and is to be used to supplement the engineering drawings. If any discrepancies occur, the engineering plans will always take precedence.



Sidewall A Sheeting Layout, Frame Line A



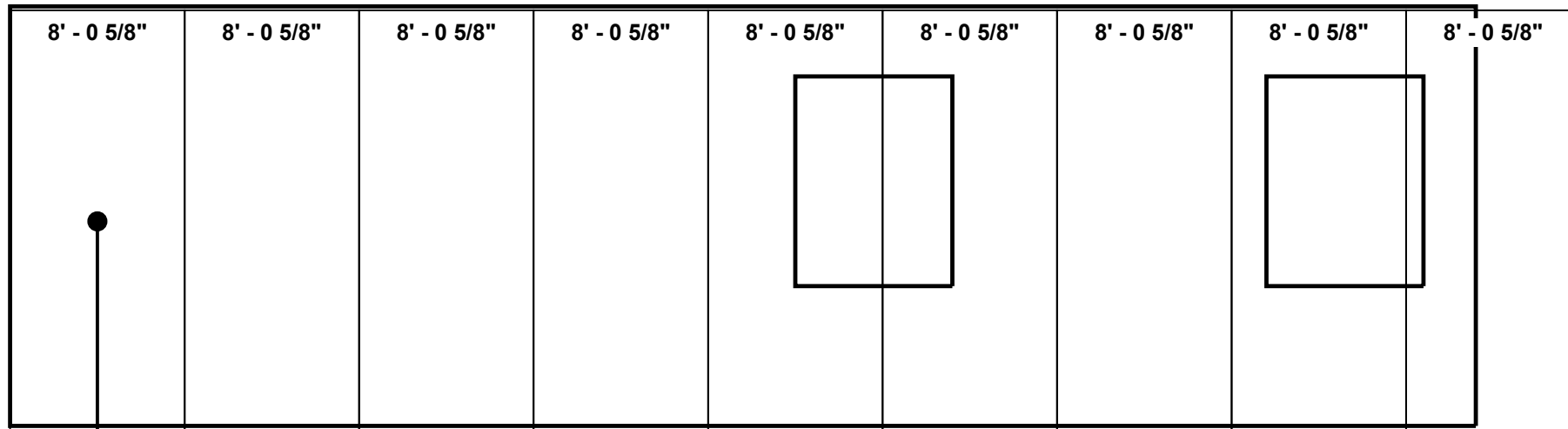

Sheeting starts with this sheet
and moves across the wall

This illustration is for reference only, and is to be used to supplement the engineering drawings. If any discrepancies occur, the engineering plans will always take precedence.



Sidewall B Sheeting Layout, Frame Line D



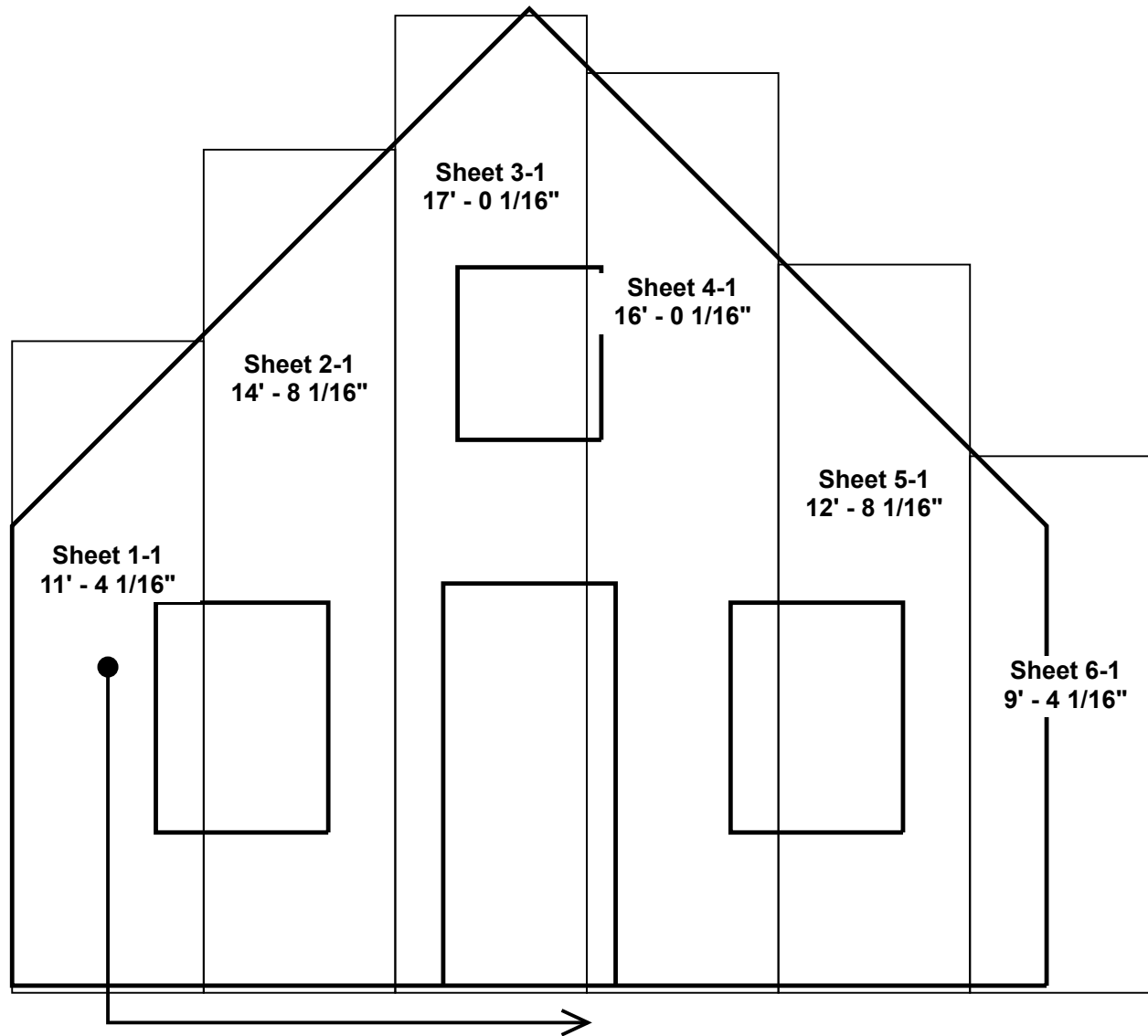

Sheeting starts with this sheet
and moves across the wall

This illustration is for reference only, and is to be used to supplement the engineering drawings. If any discrepancies occur, the engineering plans will always take precedence.



Endwall A Sheeting Layout, Frame Line 1



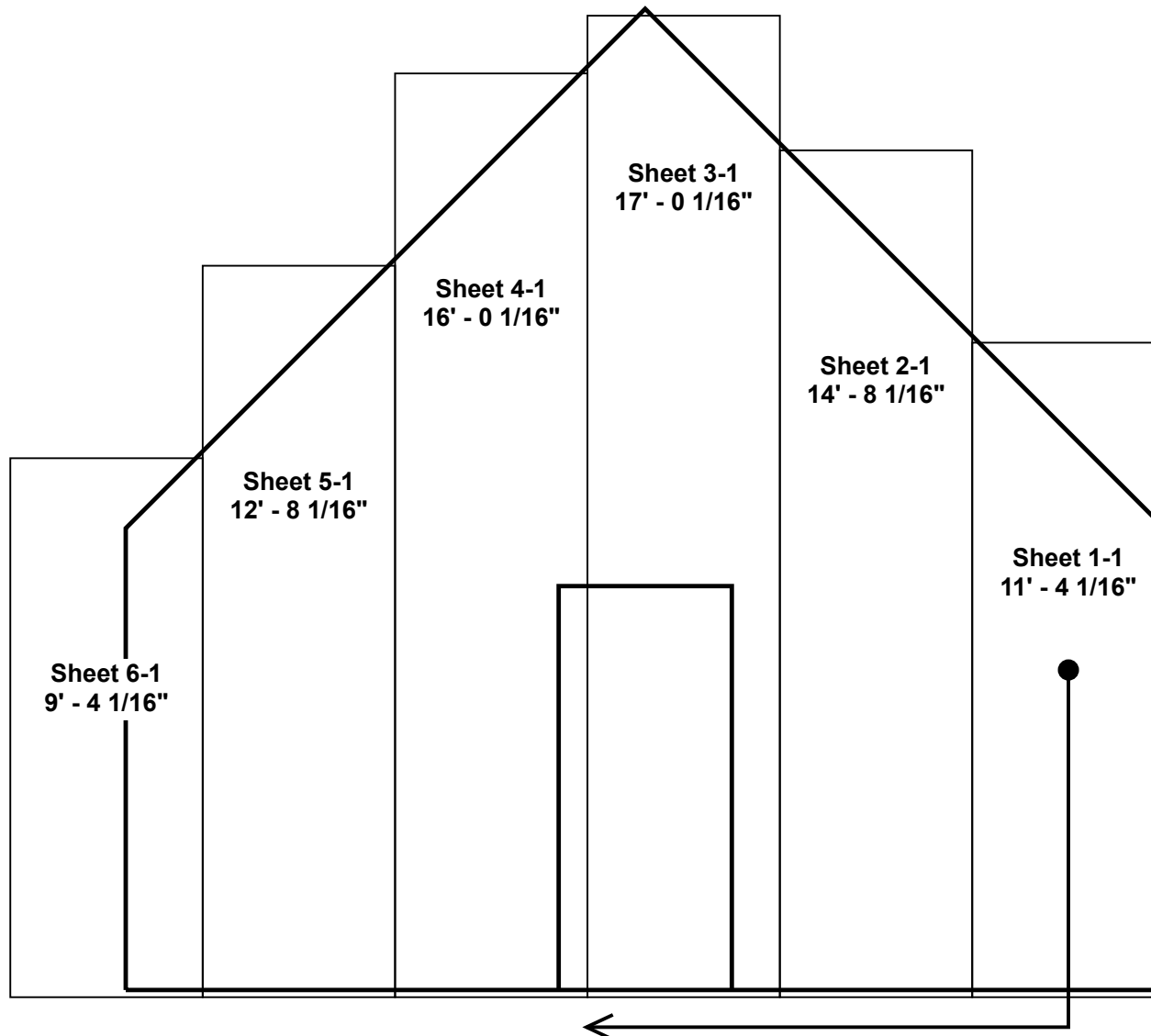

←
**Sheeting starts with this sheet
 and moves across the wall**

This illustration is for reference only, and is to be used to supplement the engineering drawings. If any discrepancies occur, the engineering plans will always take precedence.



Endwall B Sheeting Layout, Frame Line 3

